

GLIN-X450 / 600 Lateral Swing Hinge

	GLIN-X450	GLIN-X600
Door Width	400~500 mm	550~650 mm
Door Height	600~2400 mm	
Door Thickness	15~24 mm	
Door Weight	Max. 17 kg/Door	Max. 24 kg/Door
Overlay	19 mm	
Specification	<input type="checkbox"/> Single Door (Overlay)	



Features

- **Door will be flush with left and right doors when closed**
- **Door does not get in the way during and after being opened:**
Swings out laterally in small radius, ideal for tight front space application
- **Full access to cabinet maximising inside space:**
Installed to cabinet side board, maximising space inside of cabinet
- **Smooth operation:** Door can be opened and closed smoothly from any position
- **Soft close:** Door closes smoothly and softly with damper
- **Easy installation:** Arms are clipped or base
- **4-way adjustable:** Adjustable in vertical, horizontal, depth and parallel directions
- **Various application usage:** Single door, double door, and even L-shaped corner cabinets / enclosures

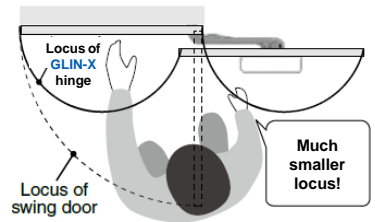
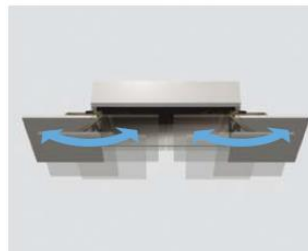
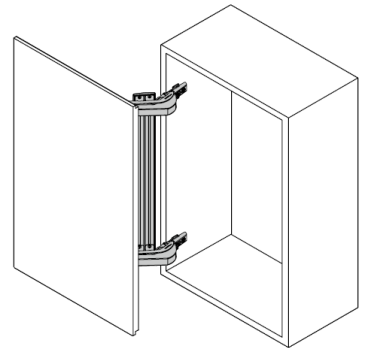

Swings out laterally in small radius, ideal for tight front space application



Installed to side board, not interfering with the movement of items, suitable for hanging doors and floor cabinets / enclosures

Easy installation and removal

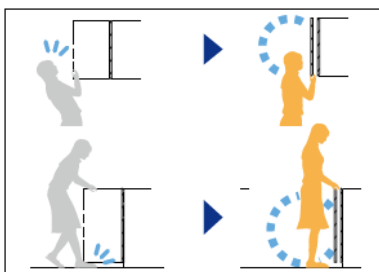

- Door does not get in the way when opening and closing.

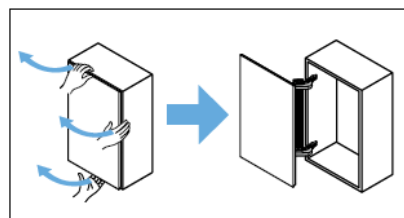

- Door can be opened and closed smoothly from any position.

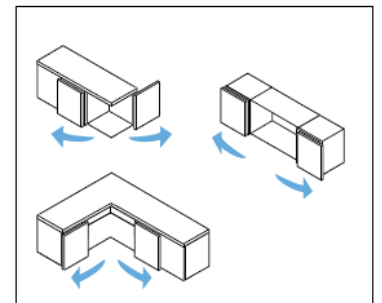

- Suitable for various cabinets.

GLIN-X450

The circled numbers are part numbers. Refer to part number table for details

Locus Chart

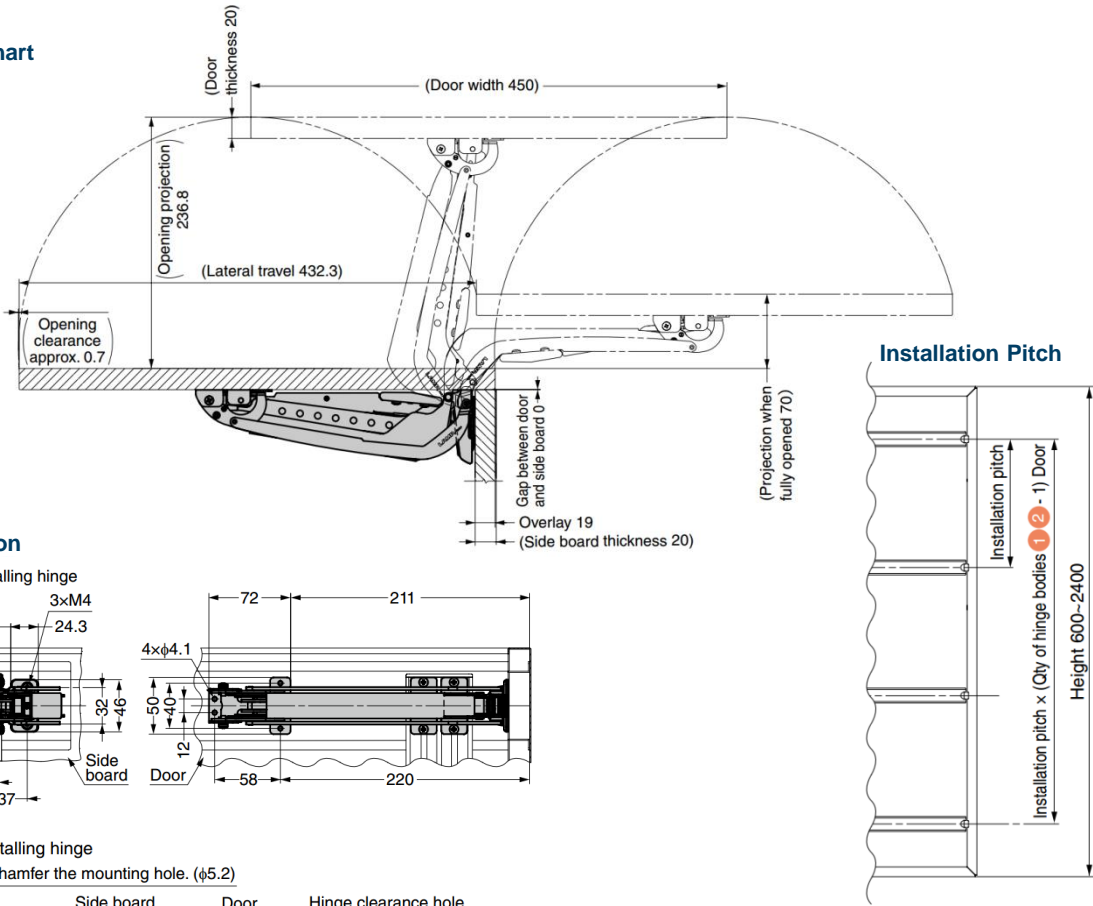

Installation

- When installing hinge

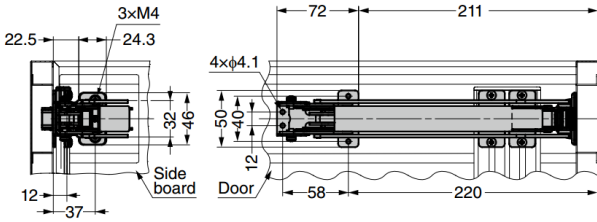

- Before installing hinge

※ Chamfer the mounting hole. (φ5.2)

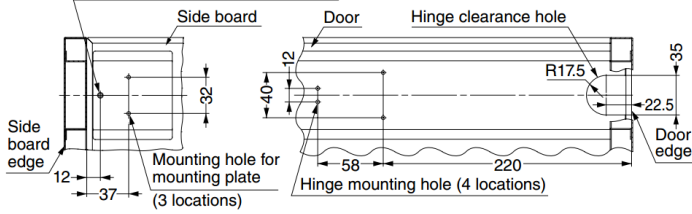

Qty of Hinge Bodies (1 + 2)	Item Name Suffix of Parts Set					
	09XX	12XX	15XX	18XX	21XX	24XX
	Connecting Bar (3) Length L					
2 Hinges per Door	490	790	1090	-	-	-
3 Hinges per Door	245	395	545	695	845	-
4 Hinges per Door	-	263	363	463	563	663
5 Hinges per Door	-	-	272.5	347.5	422.5	497.5

Parts Drawing

- Hinge body

When closed

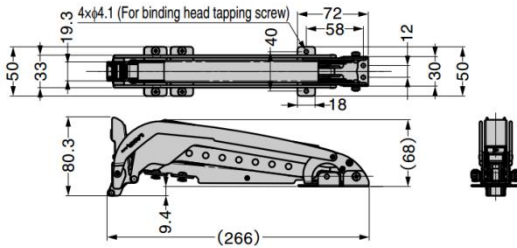

When opened

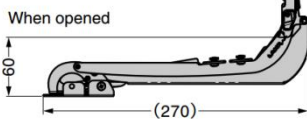

- Hole cover

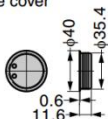

- Connecting bar

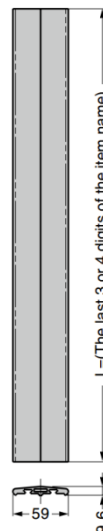

- End cap for connecting bar

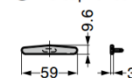

Parts Set (Per Door)

Necessary Parts

Choose based on applicable door height and door weight.



Refer to previous page for details on dimensions and descriptions of parts included in the set

Part No.	Door Height mm	Door Weight kg	Parts Included GLIN-X450				Weight (g)	
			① Hinge Set (With Catch & Damper)	② Hinge Set (Without Catch & Damper)	③ Connecting Bar	④ End Cap For Connecting Bar		
			Qty/set	Qty/set	Connecting Bar Item Name	Qty/pc		Qty/pc
GLIN-X450S-0907	600~	Max. 7	2	-	GLIN-X45-L540	1	2	4046
GLIN-X450S-0910	900	7.1~10.5	3		4812			
GLIN-X450S-1207	901~1200	Max. 7	2	1	GLIN-X45-L840	1	2	4193
GLIN-X450S-1210		7.1~10.5	3					4959
※1 GLIN-X450S-1214		10.6~14						5661
GLIN-X450S-1507	1201~1500	Max. 7	2	-	GLIN-X45-L1140	1	2	4416
GLIN-X450S-1510		7.1~10.5						
※1 GLIN-X450S-1514		10.6~14						5884
※2 GLIN-X450S-1517		14.1~17						6586
GLIN-X450S-1807	1501~1800	Max. 7	3	-	GLIN-X45-L1440	1	2	5512
GLIN-X450S-1810		7.1~10.5						
※1 GLIN-X450S-1814		10.6~14						6214
※2 GLIN-X450S-1817		14.1~17						6916
GLIN-X450S-2107	1801~2100	Max. 7	3	-	GLIN-X45-L1740	1	2	5648
GLIN-X450S-2110		7.1~10.5						
※1 GLIN-X450S-2114		10.6~14						6350
※2 GLIN-X450S-2117		14.1~17						7052
※1 GLIN-X450S-2407	2101~2400	Max. 7	3	-	GLIN-X45-L2040	1	2	6669
※1 GLIN-X450S-2410		7.1~10.5						
※1 GLIN-X450S-2414		10.6~14						6669
※2 GLIN-X450S-2417		14.1~17						-

※1: 4 hinges per door. If installing hinge set (without catch & damper) ②, please use it as the second one from the bottom.

※2: 5 hinges per door. If installing hinge set (without catch & damper) ②, please use it as the second and third ones from the bottom.

Parts Set Details

No.	Part Name	Description
①	Hinge Set (With Catch & Damper) Parts Included in 1 Set Hinge Body (With Catch & Damper)	Part No. GLIN-X450ACD
	 × 1 Hole Cover × 1 Binding Head Tapping Screw × 4 ● Material Steel ● Finish Nickel	
②	Hinge Set (Without Catch & Damper) Parts Included in 1 Set Hinge Body (With Catch & Damper)	Part No. GLIN-X450A
	 × 1 Hole Cover × 1 Binding Head Tapping Screw × 4 ● Material Steel ● Finish Nickel	

No.	Part Name	Description
③	Connecting Bar	Length 540 mm Part No. GLIN-X45-L540
		Length 840 mm Part No. GLIN-X45-L840
		Length 1140 mm Part No. GLIN-X45-L1140
		Length 1440 mm Part No. GLIN-X45-L1440
		Length 1740 mm Part No. GLIN-X45-L1740
④	End Cap for Connecting Bar	Length 2040 mm Part No. GLIN-X45-L2040
		● Material Aluminium Alloy ● Finish Anodised
④	End Cap for Connecting Bar	Part No. GLIN-X45C
		● Material POM ● Colour Grey

Mounting Plate

Necessary Parts

Mounting Plate **5** : Same qty as hinge (**1** + **2**) is necessary.

Countersunk Head Tapping Screw **6** : 3 pcs are necessary per 1 mounting plate.

No.	Part No.	Dimensions	No.	Part No.	Dimensions
5	G230-P4W-32T	Mounting Plate	6	GTAP3515NI	Raised Countersunk Head Tapping Screw 3.5×15
	<ul style="list-style-type: none"> Material Steel Finish Nickel 			<ul style="list-style-type: none"> Material Steel Finish Nickel 	For Mounting Plate

Circled numbers are part numbers, refer to part number table and part set details on previous pages

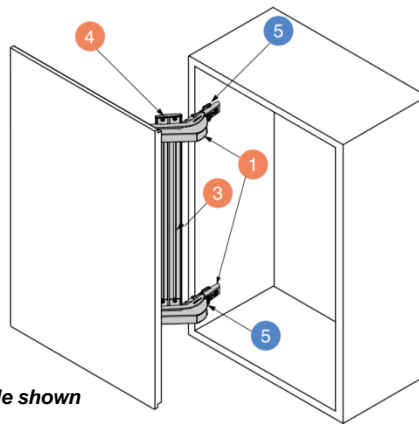

2 hinges example shown

Standard Kit with Mounting Plate

- Includes parts set and mounting plates
- Suitable for door size (width 400 ~ 500 mm, height 600 ~ 900 mm, thickness 15 ~ 24 mm) and door weight 7 kg or less

Parts Included

Hinge body	2 pcs	End cap for connecting bar	2 pcs
Mounting plate	2 pcs	Hole cover	2 pcs
Connecting bar	1 pc		
Raised countersunk head tapping screw 3.5×15	6 pcs		
Binding head tapping screw 3.5×15	8 pcs		



Kit for
GLIN-X450

Part No.	Overlay	Door Height	Door Weight	Mounting Plate (Included)
GLIN-X450	19	600 ~ 900	Max. 7 kg	G230-P4W-32T
GLIN-X450 + 5	14			G230-P4W-32T+5

GLIN-X600

The circled numbers are part numbers. Refer to part number table for details

Locus Chart

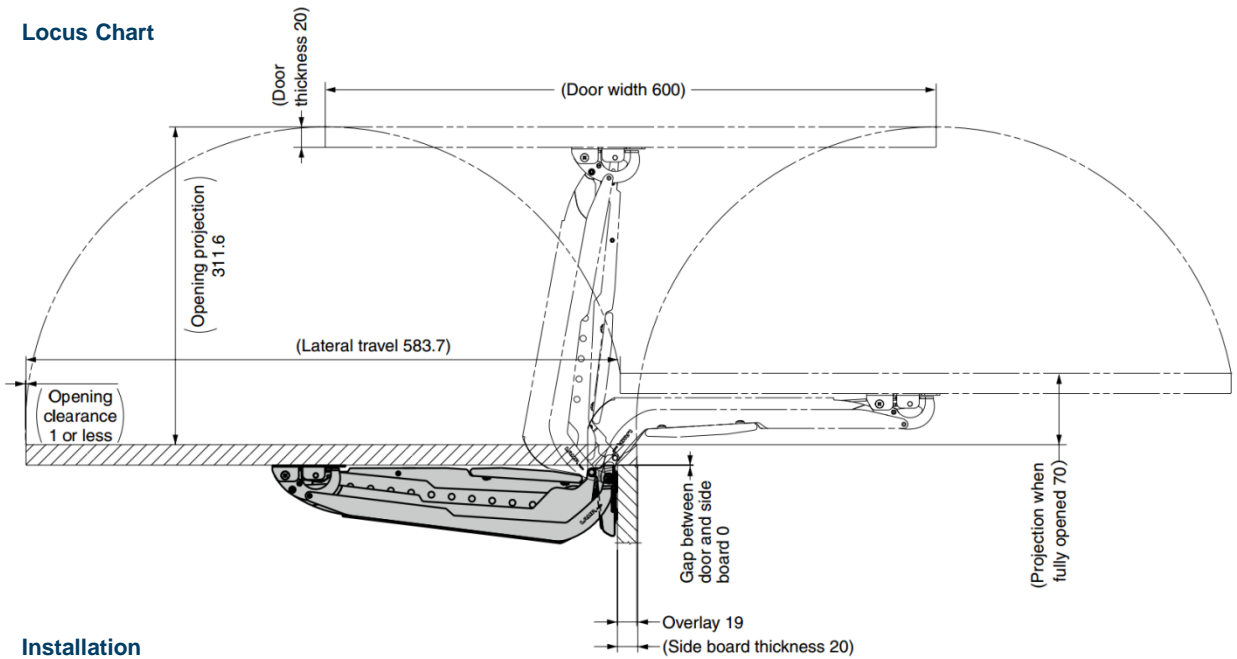

Installation

- When installing hinge

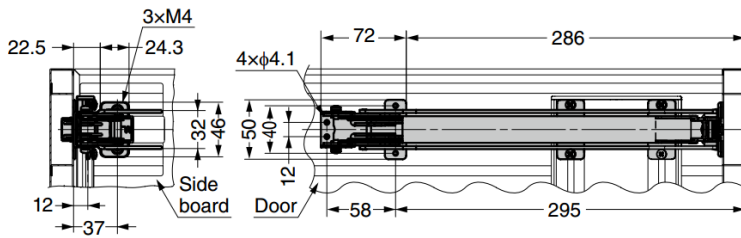

- Before installing hinge

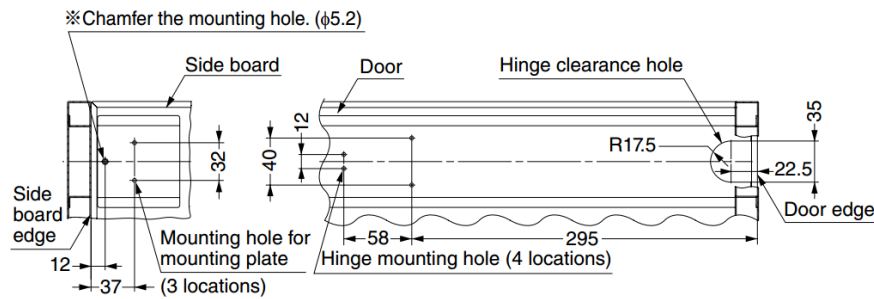

Installation Pitch

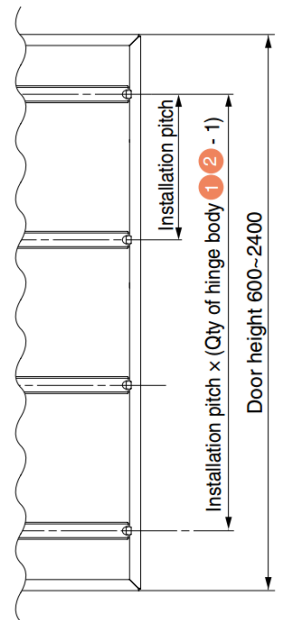

Qty of hinge bodies (1 + 2)	Item Name Suffix of Parts Set					
	09XX	12XX	15XX	18XX	21XX	24XX
	Connecting Bar ③ Length L					
	540	840	1140	1440	1740	2040
2 Hinges per Door	490	790	-	-	-	-
3 Hinges per Door	245	395	545	695	845	-
4 Hinges per Door	-	-	363	463	563	663
5 Hinges per Door	-	-	-	347.5	422.5	497.5

Parts Drawing

- Hinge body
When closed

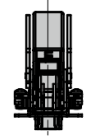
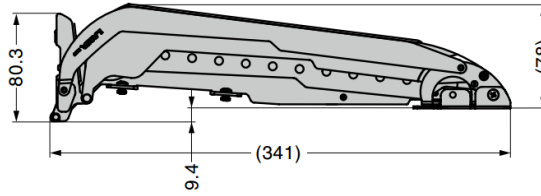
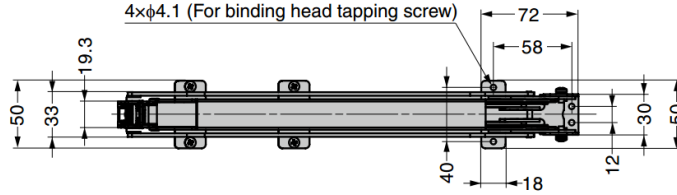

When opened

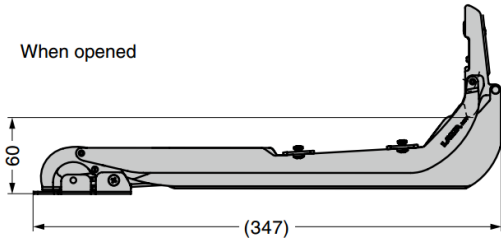

- Hole cover

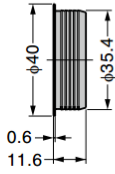

- Connecting bar

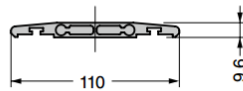
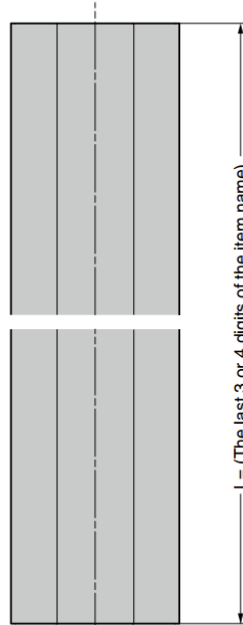

- End cap for connecting bar

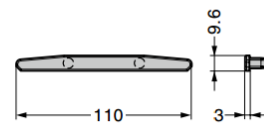

Parts Set (Per Door)

Necessary Parts.

Choose based on applicable door height and door weight.







Refer to previous page for details on dimensions and descriptions of parts included in the set

Part No.	Door Height mm	Door Weight kg	Parts Included GLIN-X600				Weight (g)
			①	②	③	④	
			Hinge Set (With Catch & Damper) Qty/set	Hinge Set (Without Catch & Damper) Qty/set	Connecting Bar Qty/pc	End Cap For Connecting Bar Qty/pc	
GLIN-X600S-0909	600~	Max. 9	2				4913
GLIN-X600S-0912	900	9.1~12	3				5930
GLIN-X600S-1212	901~	Max. 12	2				5232
GLIN-X600S-1216	1200	12.1~16		-			6270
GLIN-X600S-1512	1201~	Max. 12					6752
GLIN-X600S-1516		12.1~16					6752
※1 GLIN-X600S-1520	1500	16.1~20		1			7748
GLIN-X600S-1812	1501~	Max. 12		-			7070
GLIN-X600S-1816		12.1~16					7070
※1 GLIN-X600S-1820	1800	16.1~20		1	1	2	8066
※2 GLIN-X600S-1824		20.1~24		2			9062
GLIN-X600S-2112	1801~	Max. 12	3				7608
GLIN-X600S-2116		12.1~16					7608
※1 GLIN-X600S-2120	2100	16.1~20		1			8604
※2 GLIN-X600S-2124		20.1~24		2			9600
※1 GLIN-X600S-2412	2101~	Max. 12					9066
※1 GLIN-X600S-2416		12.1~16			1		
※1 GLIN-X600S-2420	2400	16.1~20					9066
※2 GLIN-X600S-2424		20.1~24		2			9066

※1: 4 hinges per door. If installing hinge set (without catch & damper) ②, please use it as the second one from the bottom.

※2: 5 hinges per door. If installing hinge set (without catch & damper) ②, please use it as the second and third ones from the bottom.

Parts Set Details

No.	Part Name	Description
①	Hinge Set (With Catch & Damper) Parts Included in 1 Set Hinge Body (With Catch & Damper)	Part No. GLIN-X600ACD
	 × 1	
	Hole Cover	● Material Steel
	Binding Head Tapping Screw	● Finish Nickel
	 × 1	
	 × 4	
②	Hinge Set (Without Catch & Damper) Parts Included in 1 Set Hinge Body (Without Catch & Damper)	Part No. GLIN-X600A
	 × 1	
	Hole Cover	● Material Steel
	Binding Head Tapping Screw	● Finish Nickel
	 × 1	
	 × 4	

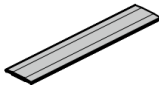
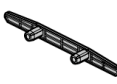
No.	Part Name	Description
③		Connecting Bar
		Length 540 mm Part No. GLIN-X60-L540
		Length 840 mm Part No. GLIN-X60-L840
		Length 1140 mm Part No. GLIN-X60-L1140
		Length 1440 mm Part No. GLIN-X60-L1440
	Length 1740 mm Part No. GLIN-X60-L1740	
	Length 2040 mm Part No. GLIN-X60-L2040	
	● Material Aluminium Alloy	
	● Finish Anodised	
④		End Cap for Connecting Bar
		Part No. GLIN-X60C
	● Material POM	
	● Colour Grey	

Mounting Plate

Necessary Parts

Mounting Plate 5 : Same qty as hinge (1 + 2) is necessary.

Countersunk Head Tapping Screw 6 : 3 pcs are necessary per 1 mounting plate.

No.	Part No.	Dimensions	No.	Part No.	Dimensions
5	G230-P4W-32T	Mounting Plate	6	GTAP3515NI	Raised Countersunk Head Tapping Screw 3.5×15
	<ul style="list-style-type: none"> Material Steel Finish Nickel 			<ul style="list-style-type: none"> Material Steel Finish Nickel 	For Mounting Plate

Circled numbers are part numbers, refer to part number table and part set details on previous pages

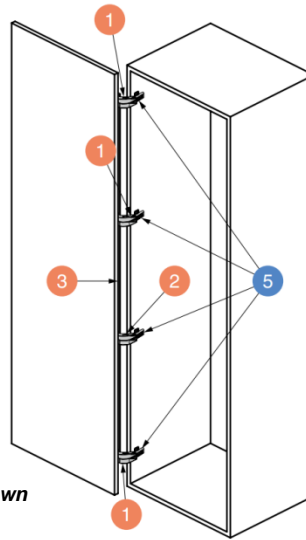

4 hinges example shown

Standard Kit with Mounting Plate

- Includes parts set and mounting plates
- Suitable for door size (width 550 ~ 650 mm, height 600 ~ 900 mm, thickness 15 ~ 24 mm) and door weight 9 kg or less

Parts Included

Hinge body	2 pcs	End cap for connecting bar	2 pcs
Mounting plate	2 pcs	Hole cover	2 pcs
Connecting bar	1 pc		
Raised countersunk head tapping screw 3.5×15	6 pcs		
Binding head tapping screw 3.5×15	8 pcs		



Kit for
GLIN-X600

Part No.	Overlay	Door Height	Door Weight	Mounting Plate (Included)
GLIN-X600	19	600 ~ 900	Max. 9 kg	G230-P4W-32T